



# NARDI

IMPLEMENTS FOR PROFESSIONAL FARMING

FCIM/G // FCI/G // FCIMV

FCI/GP // FCI

▶ VUČENA V TANJURAČA

▶ "OFFSET" DISC HARROW



[WWW.GRUPPONARDI.IT](http://WWW.GRUPPONARDI.IT)



## OPIS PROIZVODA:

Dostupni su nazubljeni ili ravni diskovi koji se nalaze u dvije podesive skupine u obliku slova V. Podesiva udaljenost strugača od diska. Podizanje pomoću hidraulične dizalice.



## DESCRIPTION:

Discs are available either plain or scalloped and set in two adjustable «V» offset gangs. Adjustable distance of scrapers from discs. Lifting of transport wheels operated by hydraulic jack.



## DESCRIPTION:

Disques lisses et crénelés montés sur deux trains en «V» à ouverture variable. Rélevageau moyen du chariot à roues pneumatiques, actionné par vérin hydraulique depuis le siège du conducteur.



## DESCRIPCIÓN:

Rastras desterronadoras discos lisos y dentados armados en dos secciones tipo «V» (offset) con angulación graduable. Limpiadiscos con distancia graduable. Levante de las secciones por medio de tren de rodaje, ruedas de goma (neumaticos) accionad por medio de martinete hidraulico y el sistema hidraulico del tractor.

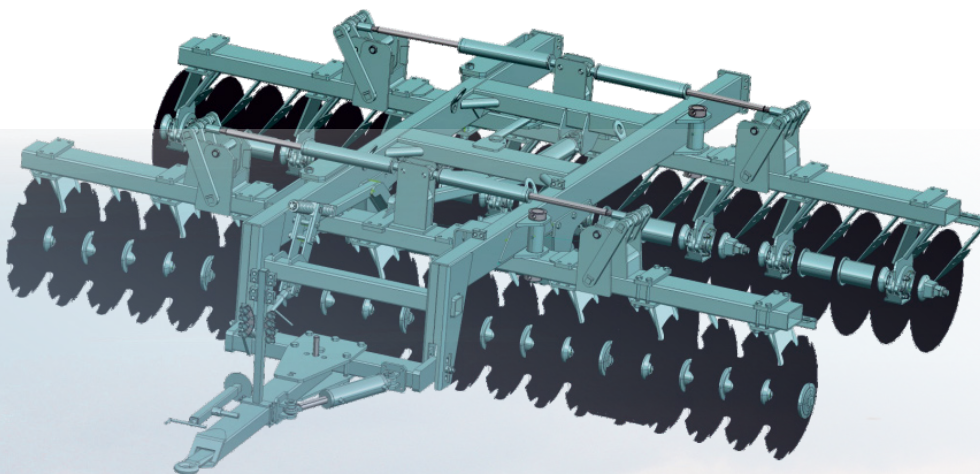

model 40 FCI 230/GP 660



Diskovi od niskolegiranog čelika, toplinski obrađeni za visoku otpornost na trošenje.









Discs in special microalloy steel, treated thermally for high wear resistance.

Disques en acier micro-allié spécial, traité thermiquement pour une résistance élevée à l'usure.

Discos en acero especial microaleados con tratamientos térmicos resistentes a desgaste.



VUČENA V TANJURAČA OD 60 DO 160 KS - "OFFSET" TRAILED DISC HARROW FROM 60 TO 160 HP - PULVERISEUR "OFFSET" DE 60 A 160 HP - RASTRAS DESTERRONADORAS "OFFSET" DE 60 A 160 HP

Model FCIM/G											
	COD	COD	KS	kW	KS	kW	cm	Broj	Broj	cm	kg
s kugličnim ležajem - with ball bearing - avec roulements à billes - con cojinetes de bolas											
20 FCIMG/61	B6131121		60-80	44-59	---	---	61	20	8	230	1.460
22 FCIMG/61	B6131221		70-90	52-67	---	---	61	22	8	253	1.520
24 FCIMG/61	B6131321		70-100	52-74	---	---	61	24	8	275	1.580
26 FCIMG/61	B6131421		80-110	59-82	---	---	61	26	8	298	1.640
28 FCIMG/61	B6131521		80-130	59-97	---	---	61	28	8	320	1.700
32 FCIMG/61	B6131721	B6131716	100-140	74-104	---	---	61	32	12	365	1.910
36 FCIMG/61	B6131921		110-160	82-119	---	---	61	36	12	410	2.020
s koničnim valjkastim ležajem - with taper roller bearing - avec roulements à rouleaux conique - con cojinetes de rodillos cónicos											
20 FCIMG/61	B6131126	B6131127	60-80	44-59	---	---	61	20	8	230	1.480
22 FCIMG/61	B6131226	B6131227	70-90	52-67	---	---	61	22	8	253	1.540
24 FCIMG/61	B6131326	B6131327	70-100	52-74	---	---	61	24	8	275	1.600
26 FCIMG/61	B6131426	B6131427	80-110	59-82	---	---	61	26	8	298	1.660
28 FCIMG/61	B6131526	B6131527	80-130	59-97	---	---	61	28	8	320	1.720
32 FCIMG/61	B6131726	B6131727	100-140	74-104	---	---	61	32	12	365	1.940

STANDARDNA OPREMA - STANDARD FEATURES

- Hidraulično podešavanje kuta sekcija - Hydraulic section angle adjustment - Réglage hydraulique de l'angle de section - Ajuste del ángulo de la sección hidráulica
- Dvostruko podešavanje smjera strugača - Double direction adjustment of scrapers - Réglage à double direction des décroittoirs - Doble dirección regulación de los rasadores
- Varijacija kuta stražnje sekcije u odnosu na prednju - Angle variation of rear section with respect to front - Variation de l'angle de la section arrière par rapport à l'avant - Variación del ángulo de la sección trasera con respecto al frente.

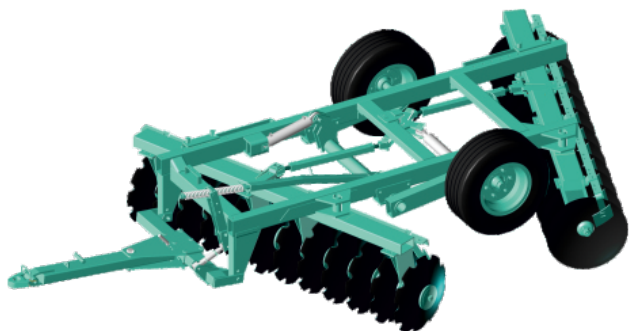

model 24 FCIM/G 61











FCIM/G-FCIM/GP



FCI230/G-FCI230/GP-FCI280/G

Kućište ležaja s koničnim samopodešavajućim zapečaćenim ležajima zaštićenim s dvostrukim uvodnicima.  
Support mounted on taper roller bearings self aligning sealed T.R.B, regreasables protected by double grommets.  
Paliers montés sur roulements à rouleaux coniques, à alignement automatique, protégés par double étanchéité, regraissable.  
Soporte con cojinetes de rodillos cónicos oscilantes reengrasables con doble arandela de compresión.

TEŠKA VUČENA V TANJURAČA OD 90 DO 300 KS - "OFFSET" HEAVY DUTY TRAILED DISC HARROW FROM 90 TO 300 HP PULVERISEUR "OFFSET" SÉRIE LOURDE DE 60 A 160 HP - RASTRAS DESTERRONADORAS SERIE PESADA "OFFSET" DE 90 A 300 HP

Model FCI 230/G FCI 280/G											
	COD	COD	KS	kW	KS	kW	cm	Broj	Broj	cm	kg
s koničnim valjkastim ležajem - with taper roller bearing - avec roulements à rouleaux conique - con cojinetes de rodillos cónicos											
20 FCI 230/G	B6134042	B6134043	90-110	66-80	---	---	66	20	8	230	2.200
22 FCI 230/G	B6134142	B6134143	90-120	66-88	---	---	66	22	8	250	2.280
24 FCI 230/G	B6134242	B6134243	100-140	73-102	---	---	66	24	8	275	2.465
26 FCI 230/G	B6134342	B6134343	110-160	80-117	---	---	66	26	8	297	2.550
28 FCI 230/G	B6134442	B6134443	120-170	88-125	---	---	66	28	8	320	2.630
32 FCI 230/G	B6134642	B6134643	130-180	95-132	---	---	66	32	12	365	2.925
36 FCI 230/G	B6134842	B6134843	140-200	102-147	---	---	66	36	12	410	3.125
40 FCI 230/G	B6134942	B6134943	170-210	125-154	---	---	66	40	12	455	3.275
44 FCI 230/G	B6134955	B6134954	180-240	132-176	---	---	66	44	12	500	3.425
48 FCI 230/G	B6134155	B6134154	200-300	147-198	---	---	66	48	12	550	3.575
s koničnim valjkastim ležajima - with taper roller bearing - avec roulements à rouleaux conique - con cojinetes de rodillos cónicos											
18 FCI 230/G	B6134163	B6134164	90-110	66-80	---	---	66	18	8	250	2.265
20 FCI 230/G	B6134263	B6134264	90-110	66-80	---	---	66	20	8	275	2.365
22 FCI 230/G	B6134363	B6134364	90-120	66-88	---	---	66	22	8	300	2.465
24 FCI 230/G	B6134463	B6134464	100-140	73-102	---	---	66	24	8	330	2.560
26 FCI 230/G	B6134563	B6134564	110-160	80-117	---	---	66	26	8	355	2.665
28 FCI 230/G	B6134663	B6134664	120-170	88-125	---	---	66	28	8	385	2.760
30 FCI 230/G	B6134763	B6134764	130-180	95-132	---	---	66	30	8	410	2.860
32 FCI 230/G	B6134863	B6134864	140-200	102-147	---	---	66	32	12	440	3.105
34 FCI 230/G	B6134966	B6134962	170-210	125-154	---	---	66	34	12	468	3.210
36 FCI 230/G	B6134066	B6134062	180-240	132-176	---	---	66	36	12	496	3.320

STANDARDNA OPREMA - STANDARD FEATURES

- Hidraulično podešavanje kuta sekcija - Hydraulic section angle adjustment - Réglage hydraulique de l'angle de section - Ajuste del ángulo de la sección hidráulica
- Dvostruki konični valjkasti ležaji - Double taper roller bearing - Double roulements à rouleaux conique - Doble cojinetes de rodillos cónicos
- Podesivi strugači - Adjustable scrapers - Décroittoirs réglables - Rasadores ajustables.

model 24 FCI230/G

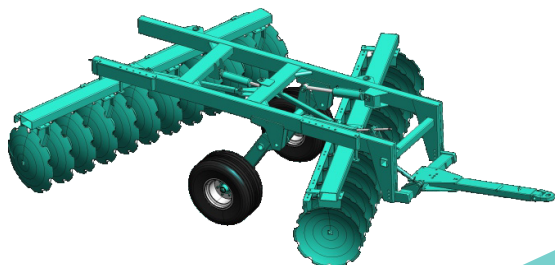

# FCIMV//

VUČENA V TANJURAČA VERTIKALNO SKLOPIVA OD 100 DO 200 KS  
"OFFSET" VERTICALLY FOLDABLE TRAILED DISC HARROW FROM 100 TO 200 HP  
PULVERISEUR "OFFSET" REPLIABLE VERTICALEMENT DE 100 A 200 HP  
RASTRAS DESTERRONADORAS PLEGABLE VERTICALMENTE "OFFSET" DE 100 A

Veći ležaji sa zaštitnom skijom  
Bigger bearings with skid for protection  
Supports de dimension augmentée avec patin de protection  
Soportes aumentado con patin de protección

Hidraulička varijacija visine rude i raspodjele opterećenja naprijed/nazad  
Hydraulic variation drawbar height and front/rear load  
Variateur hydraulique hauteur oeillet et du charge avant/arrière

Okretno oko rude  
Rotating towing eye  
Oeillet rotatif  
Gancho tiro rotativo

Više prostora između okvira i diskova  
More space between the frame and discs  
Plus d'espace entre le cadre et les disques









Uklonjiva produžena osovina  
Removable extended axle  
Essieu amovible étendu

model 36 FCIMV

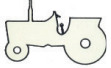
Veći standardni kotači  
Larger standard wheels  
Roues larges de série  
Ruedas anchas de serie

Neovisno podešavanje kuta naprijed/nazad  
Hydraulic independent angle adjustment front rear  
Angulation hydraulique indépendant avant/arrière  
Angulación hidráulica



Model FCIMV											
	COD	COD	KS	kW	KS	kW	cm	Broj	Broj	cm	kg
s koničnim valjkastim ležajem - with taper roller bearing - avec roulements à rouleaux conique - con cojinetes de rodillos cónicos											
28 FCIMV	B6137112	B6137111	100-140	74-104	---	---	61	28	8	320	2.470
32 FCIMV	B6137212	B6137211	89-160	66-119	---	---	61	32	8	365	2.585
36 FCIMV	B6137312	B6137311	140-180	104-134	---	---	61	36	10	410	2.700

## STANDARDNA OPREMA - STANDARD FEATURES - DESSINS DE SÉRIE - DOTACIONES DE

- Potpora na dvostrukim koničnim valjkastim ležajima - Support on double taper roller bearing - Supports avec double roulements à rouleaux conique - Soporte doble cojinetes de rodillos cónicos
- Hidrauličko podešavanje kuta sekcija - Hydraulic section angle adjustment - Réglage hydraulique de l'angle de section - Ajuste del ángulo de la sección hidráulica
- Podesivi strugači - Adjustable scrapers - Décroittoirs réglables - Rasadores ajustables
- Veći standardni kotači 400/60-15,5 Pr 14 - Large wheel as standard 400/60-15,5 Pr 14 - Roues larges de série 400/60-15,5 Pr 14 - Ruedas anchas de serie 400/60-15,5 Pr 14.



Transportna širina 2,50 m.  
Road overall dimension 2.50 m.  
Encombrement routier 2.50 m.  
Gàlibo del vehiculo 2.50 m.

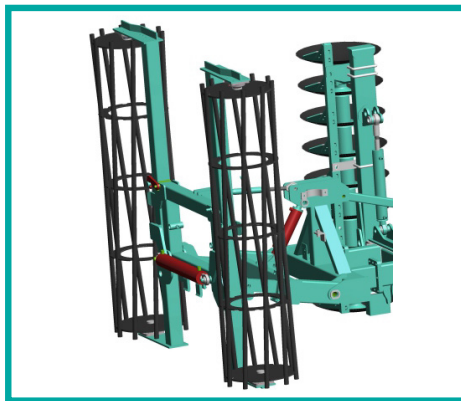









Hidraulički stražnji nosač u 3 točke za kultivatore i valjke, itd.  
Hydraulic rear carrier a three point for cultivators and rollers, etc.  
Porte-outils arrière à 3 points hydraulique pour les rouleaux ou cultivateurs  
Portaherramientas trasero hidráulico de tres punto para rodillos y coltivadores.









Visoka prohodnost u transportu.  
Extremely underbeam clearance transport  
Elevé hauteur sous age pour le transport  
Luz-libre elevada para el transporte.

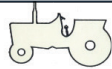
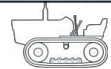

**TEŠKA VUČENA V TANJURAČA SKLOPIVA OD 120 DO 400 KS**  
**"OFFSET" FOLDABLE HEAVY DUTY TRAILED DISC HARROW FROM 120 TO 400 HP**  
**PULVERISEUR "OFFSET" REPLIABLE SÉRIE LOURDE DE 120 A 400 HP**  
**RASTRAS DESTERRONADORAS SERIE PESADA PLEGABLE "OFFSET" DE 120 A 400 HP**









Model FCI 230/GP FCI 280/GP											
	COD	COD	KS	kW	KS	kW	cm	Broj	Broj	cm	kg
<b>Teška - Heavy duty - Série lourde - Serie pesada</b>											
28 FCI 230/GP	B6132004	B6132003	130-160	96-119	---	---	66	28	12	320	3.055
32 FCI 230/GP	B6132204	B6132203	160-180	119-134	---	---	66	32	16	365	3.570
36 FCI 230/GP	B6132404	B6132403	180-200	134-149	---	---	66	36	16	410	3.710
40 FCI 230/GP	B6132604	B6132603	200-250	149-186	---	---	66	40	16	455	3.865
44 FCI 230/GP	B6132804	B6132803	250-300	186-223	---	---	66	44	16	500	4.030
48 FCI 230/GP	B6132904	B6132903	300-350	223-261	---	---	66	48	16	550	4.372
<b>Teška - Heavy duty - Série lourde - Serie pesada</b>											
28 FCI 280/GP	B6132016	B6132061	180-200	134-149	---	---	66	28	12	380	3.890

Model FCI 230/GP FCI 280/GP									
	KS	kW	KS	kW	cm	Broj	Broj	cm	kg
<b>Teška - Heavy duty - Série lourde - Serie pesada</b>									
52 FCI 230/GP	280-340	208-253	---	---	66	52	16	590	5.710
56 FCI 230/GP	310-370	231-275	---	---	66	56	16	640	5.870
60 FCI 230/GP	340-400	253-298	---	---	66	60	16	685	6.030
<b>Teška - Heavy duty - Série lourde - Serie pesada</b>									
44 FCI 280/GP	280-340	208-253	---	---	66	44	16	590	5.420
48 FCI 280/GP	310-370	231-275	---	---	66	48	16	640	5.650
52 FCI 280/GP	340-400	253-298	---	---	66	52	16	685	5.880

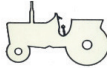
**STANDARDNA OPREMA - STANDARD FEATURES - DESSINS DE SÉRIE - DOTACIONES DE**

- Hidraulično podešavanje kuta sekcija - Hydraulic section angle adjustment - Réglage hydraulique de l'angle de section - Ajuste del ángulo de la sección hidráulica
- Podesivi strugači - Adjustable scrapers - Décroittoirs réglables - Rasadores ajustables
- Veći standardni kotači 400/60-15,5 - Large wheel as standard 400/60-15,5 - Roues larges de série 400/60-15,5 - Ruedas anchas de serie 400/60-15,5.
- Potpora na dvostrukim koničnim valjkastim ležajima - Support on double taper roller bearing - Paliers avec double roulements à rouleaux conique - Soporte doble cojinetes de rodillos cónicos.

**TEŠKA VUČENA V TANJURAČA OD 150 DO 600 KS**  
**"OFFSET" HEAVY DUTY TRAILED DISC HARROW FROM 150 TO 600 HP**  
**PULVERISEUR "OFFSET" SÉRIE LOURDE DE 150 A 600 HP**  
**RASTRAS DESTERRONADORAS SERIE PESADA "OFFSET" DE 160 A 600 HP**

Model FCI 340 - 500											
	COD	COD	KS	kW	KS	kW	cm	Broj	Broj	cm	kg
<b>Razmak diskova 34 cm - Disc spacing 34 cm - Espace entre les disques 34 cm - Espacio entre los discos 34 cm</b>											
16 FCI 340	B6139091	B6139090	150-170	110-125	100	74	81	16	6	261	3.090
18 FCI 340	B6139191	B6139190	180-200	132-147	110	81	81	18	6	295	3.285
20 FCI 340	B6139291	B6139290	200-220	147-162	120	88	81	20	6	330	3.405
24 FCI 340	B6139491	B6139490	230-260	169-184	120-150	88-110	81	24	8	390	3.890
30 FCI 340	B6139791	B6139790	280-300	206-220	150-180	110-132	81	30	8	490	4.370
<b>Razmak diskova 50 cm - Disc spacing 50 cm - Espace entre les disques 50 cm - Espacio entre los discos 50 cm</b>											
16 FCI 500	B6140435	---	300-400	224-298	---	---	91	16	8	390	7.660
18 FCI 500	B6140535	---	330-450	246-335	---	---	91	18	8	440	7.940
20 FCI 500	B6140635	---	360-500	268-373	---	---	91	20	8	490	8.600
24 FCI 500	B6140835	---	390-550	291-410	---	---	91	24	8	590	8.870
<b>Versione rinforzata - Reinforced version - Version renforcée - Versión reforzada</b>											
16 FCI 500 R	B6140442	---	320-420	238-313	---	---	91	16	8	390	9.290
18 FCI 500 R	B6140542	---	350-450	260-335	---	---	91	18	8	440	9.570

**STANDARDNA OPREMA - STANDARD FEATURES - DESSINS DE SÉRIE - DOTACIONES DE**

- Hidrauličko podešavanje kuta sekcija (FCI500-500R) - mehaničko (FCI340) - Hydraulic section angle adjustment (FCI500-500R) mechanical (FCI340) - Réglage hydraulique de l'angle de section (FCI500-500R) mécanique (FCI340) - Ajuste del ángulo de la sección hidráulica (FCI500-500R) mecánica (FCI340)
- 4 kotača 500/60 22.5 PR12 na FCI 500 R - N° 4 Wheel 500/60 22.5 PR12 on FCI 500 R - N° 4 Roues 500/60 22.5 PR12 sur FCI 500 R - N° 4 Ruedas 500/60 22.5 PR12 en FCI 500 R
- Dvostruki konični valjkasti ležaji - Double taper roller bearing - Double roulements à rouleaux conique - Doble cojinetes de rodillos cónicos
- Kotači 400/60-15,5 na FCI 340 - Wheel 400/60-15,5 on FCI 340 - Roues 400/60-15,5 sur FCI 340 - Ruedas 400/60-15,5 en FCI 340
- 2 kotača G.405/70-R20 MPT na FCI 500 - 2 Wheel G.405/70-R20 MPT on FCI 500 - 2 Roues G.405/70-R20 MPT sur FCI 500 - 2 Ruedas G.405/70-R20 MPT en FCI 500
- Podesivi strugači - Adjustable scrapers - Décroittoirs réglables - Rasadores ajustables

Radni podaci i podaci o masi u ovom letku daju se samo radi informacija i nisu obavezujući.  
 The weight and working data contained in the present leaflet are supplied for information only and are not binding.

Les descriptions et illustrations de cette notice sont données à titre indicatif et sans engagement.

Los datos de peso y trabajo del presente folleto son a simple titulo informativo.

ASSOCIATI:



**NARDI**

**IMPLEMENTS FOR PROFESSIONAL FARMING**

Via del Lavoro 24/26 - 06016 Selci Lama (PG) Italy

tel. +39 075 8610611 - fax +39 075 8583446

www.grupponardi.it - e-mail: info@grupponardi.it

Facebook.com/Nardi.spa